

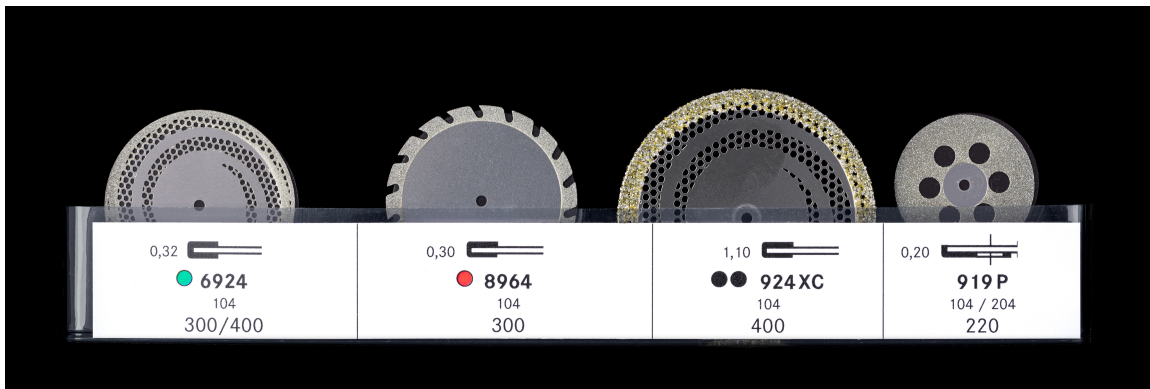

Campionario DISCHI DIAMANTATI LABORATORIO

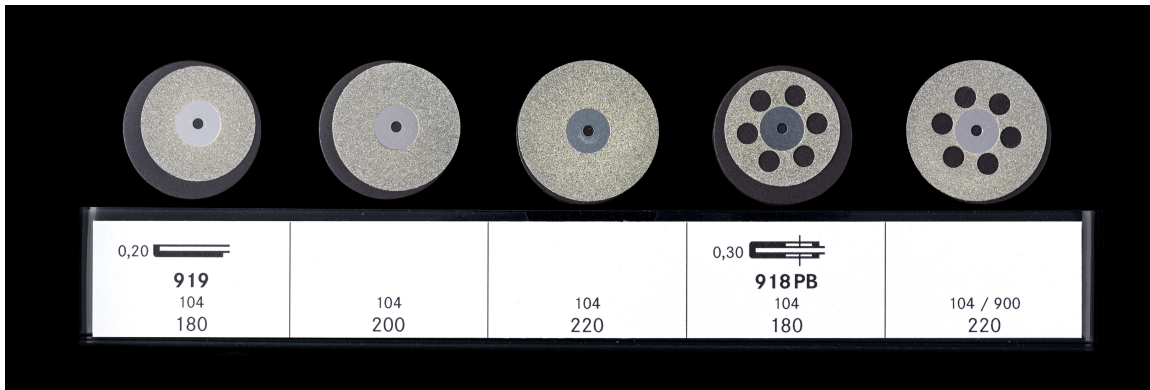

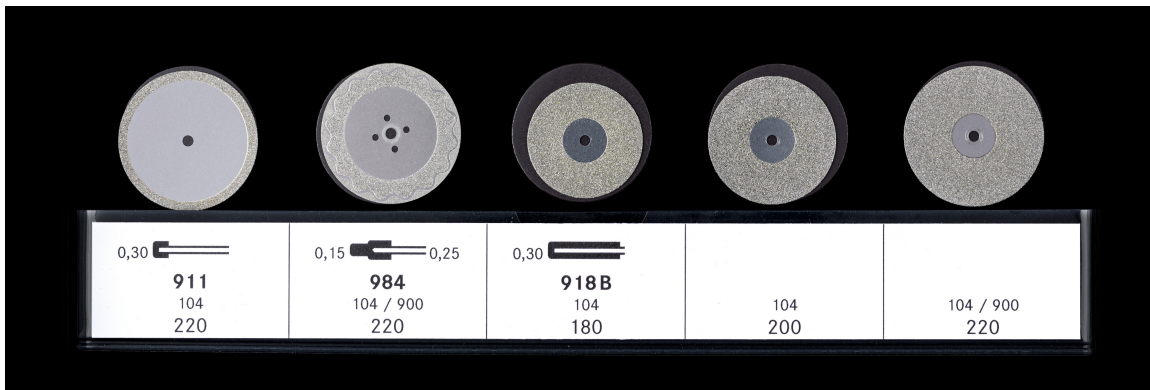
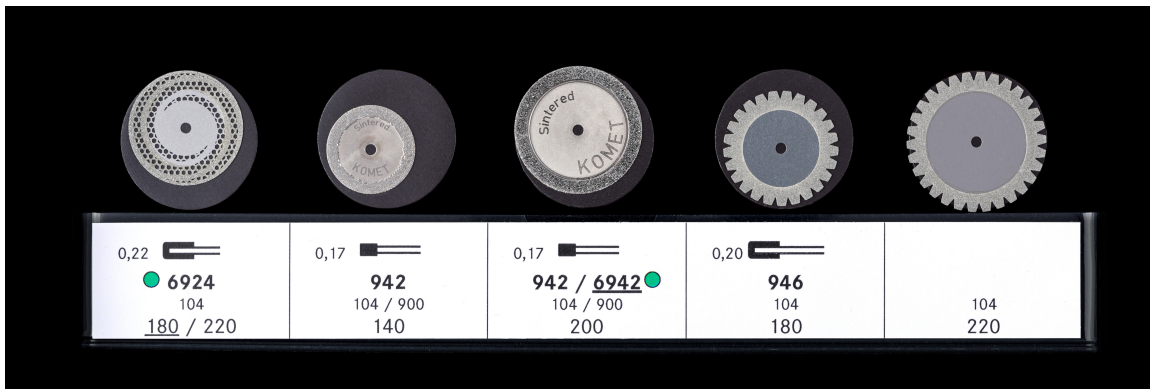
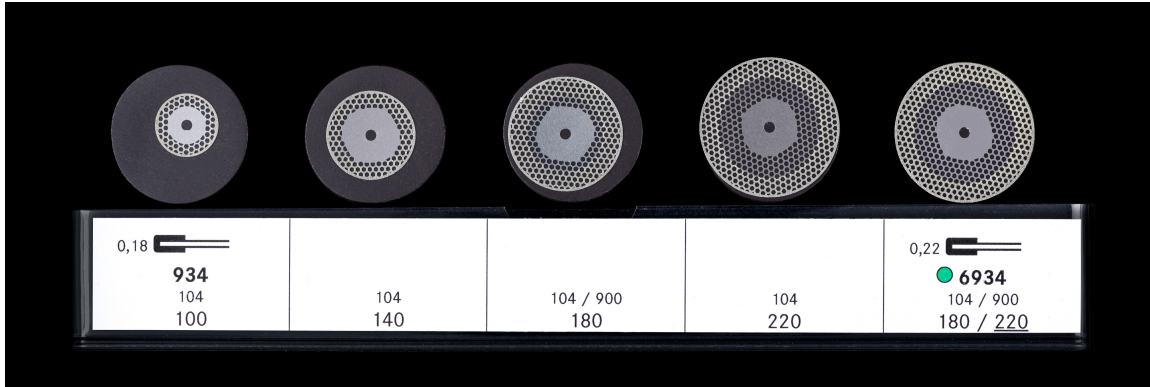

Campionario DISCHI DIAMANTATI LABORATORIO

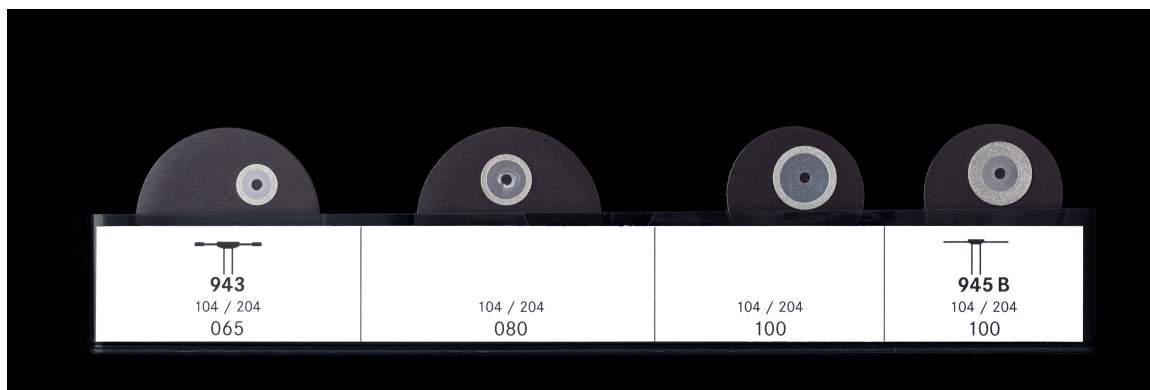
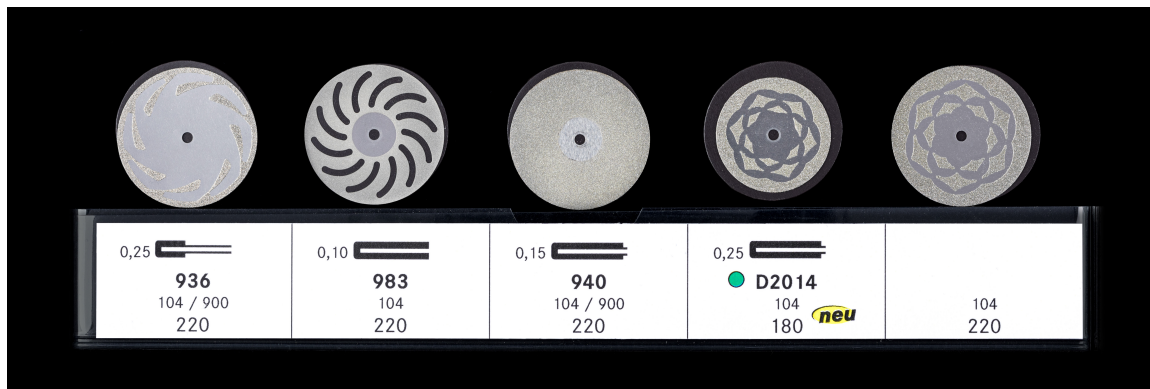
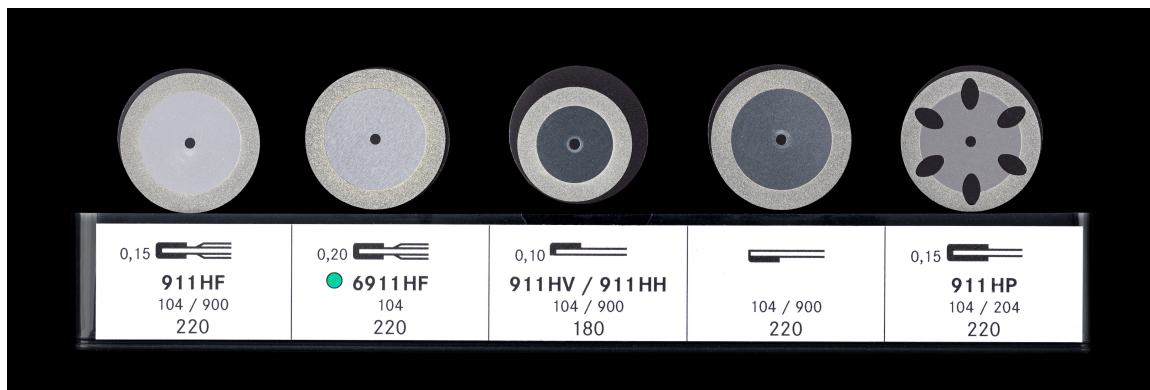
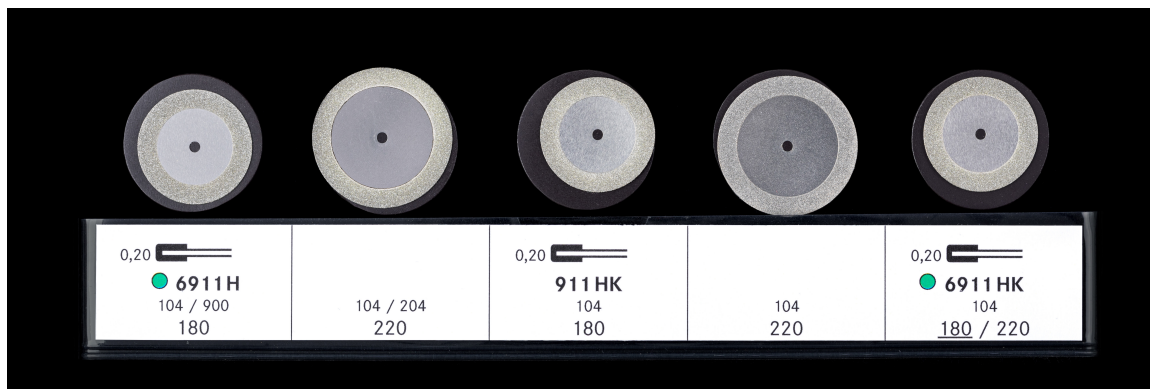
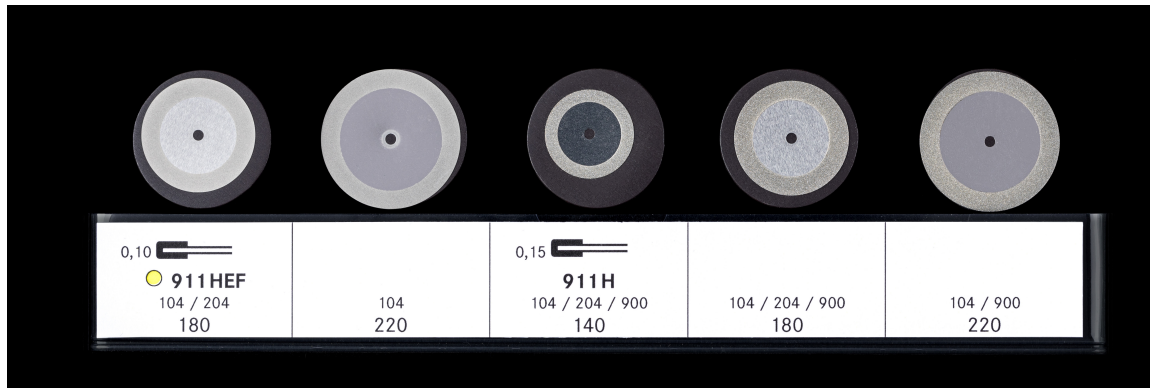

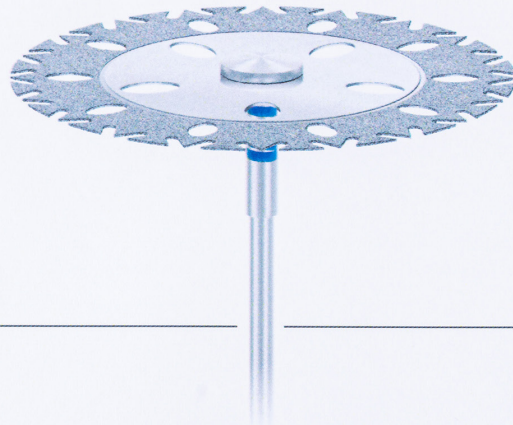

987P



Groß und effektiv

Vorteile:

- großer Durchmesser
- Sägeverzahnung
- hohe Stabilität und Standzeit
- Perforationen für gute Sicht auf das Einsatzgebiet
- geeignet für Gips und Modellkunststoff
- geeignet für Rechts- und Linkslauf

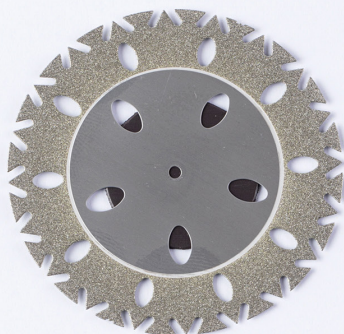

987P.104.480

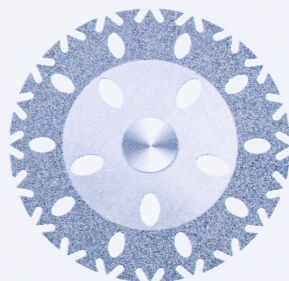











987P.104.400 **neu**





- flexibel
- bruchsticher
- langlebig

Die neuen gewebeverstärkten Trennscheiben

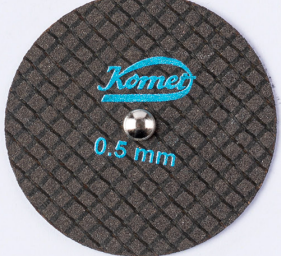
	9527		Diamantkorn durchsetzte Trennscheibe für alle Keramiken 0,3 x 20 mm
	9528	 	ultradünne Trennscheibe für EM-Legierungen 0,2 x 22 mm / 26 mm
	9529	 	dünne Trennscheibe für EM- und NEM-Legierungen 0,3 x 22 mm / 26 mm
	9530	 	mitteldicke Trennscheibe für NEM-Legierungen 0,5 x 22 mm / 26 mm
			0,5 x 40 mm



Trennscheiben für Metall-Legierungen

9500
0,3 x 22 mm



9501
0,6 x 22 mm



9506
0,2 x 22 mm

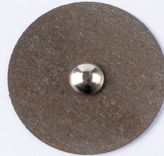

9512
0,6 x 22 mm



Schleifscheiben für Metall-Legierungen

9507
1,0 x 25 mm



9507
1,0 x 40 mm

